

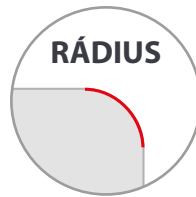

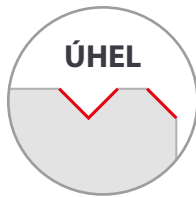











POMOCNÍCI Z TVRDOKOVU PRO CNC OBRÁBĚNÍ



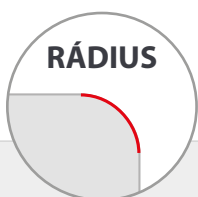

TYP	Provedení	Rozsah průměrů (mm)	Úhel						Povlak	Počet břitů	Stránka katalogu		
			20°	30°	45°	60°	90°	120°				142°	
NC NAVRTÁVÁKY	 2SPOC	DÉLKA ≤ 150mm	Ø0,3 - Ø16					<input checked="" type="checkbox"/>	<input checked="" type="checkbox"/>	<input checked="" type="checkbox"/>	TiSiN	2	str. 4
	 2680	APPLITEC	Ø0,5 - Ø20					<input checked="" type="checkbox"/>	<input checked="" type="checkbox"/>		-	2	str. 5
	 2520-30	APPLITEC OSAZENÁ STOPKA	Ø5 - Ø12					<input checked="" type="checkbox"/>	<input checked="" type="checkbox"/>		-	2	str. 5
GRAVÍROVACÍ FRÉZY	 1STE	GRAVÍROVÁNÍ		<input checked="" type="checkbox"/>	<input checked="" type="checkbox"/>			<input checked="" type="checkbox"/>	<input checked="" type="checkbox"/>		TiSiN	1	str. 6
	 2STEC	GRAVÍROVÁNÍ SRÁŽENÍ HRAN	Ø3 - Ø12		<input checked="" type="checkbox"/>		<input checked="" type="checkbox"/>	<input checked="" type="checkbox"/>	<input checked="" type="checkbox"/>		TiSiN	2	str. 7
SRÁŽEČE	 3CHA	SRÁŽENÍ HRAN nižší řezný odpor	Ø3 - Ø12					<input checked="" type="checkbox"/>			TiSiN	3	str. 8
	 4STE	SRÁŽENÍ HRAN	Ø3 - Ø12				<input checked="" type="checkbox"/>	<input checked="" type="checkbox"/>			TiSiN	4	str. 8
	 4,6TDA	OBOUSTRANNÉ SRÁŽENÍ HRAN	Ø1,5 - Ø12				<input checked="" type="checkbox"/>	<input checked="" type="checkbox"/>			AlCrN	4 - 6	str. 9
	 4,6TAC	FRÉZA ÚHLOVÁ ČELNÍ	Ø1,5 - Ø12		<input checked="" type="checkbox"/>	<input checked="" type="checkbox"/>					AlCrN	4 - 6	str. 10



TYP	Provedení	Rozsah průměrů (mm)	Rozsah rádiusů (mm)	Povlak	Počet břitů	Stránka katalogu	
ZAOBLOVACÍ FRÉZY	 2CRC	ZAOBLOVÁNÍ HRAN	Ø0,8 - Ø20	R0,1 - R8	TiSiN	2	str. 11
	 4CRC	ZAOBLOVÁNÍ HRAN	Ø4 - Ø16	R0,5 - R6	TiSiN	4	str. 11
	 3TRC	OBOUSTRANNÉ ZAOBLOVÁNÍ HRAN	Ø1,9 - Ø11,9	R0,2 - R3	AlCrN	3	str. 12
3D OBRÁBĚNÍ	 4JJSPM	3D SRÁŽENÍ HRAN	Ø1 - Ø6	R0,5 - R3	TiSiN-S	4	str. 13



			Provedení	Rozsah PRŮMĚRŮ (mm)	Rozsah TLOUŠTKY (mm)	Povlak	Počet břitů	Stránka katalogu	
T- FRÉZY		4TES	DRÁŽKY	Ø2 - Ø10	0,3 - 3	AlCrN	4	str. 14	
		4TRS	RÁDIUSOVÉ DRÁŽKY	Ø5 - Ø12	1 - 6	AlCrN	4	str. 15	
PILOVÉ KOTOUČE		1101	JEMNOZUBÉ	Ø15 - Ø160	0,1 - 6	-	≤ 160	str. 16 - 17	
		1102	HRUBOZUBÉ	Ø15 - Ø160	0,2 - 6	-	≤ 80	str. 16 - 17	
		1103	EXTRA JEMNOZUBÉ	Ø8 - Ø80	0,1 - 3	-	≤ 160	str. 18	
		2810	Upínací trny s ČELNÍM upínáním						str. 19
		2820	Upínací trny se ZADNÍM upínáním						str. 19

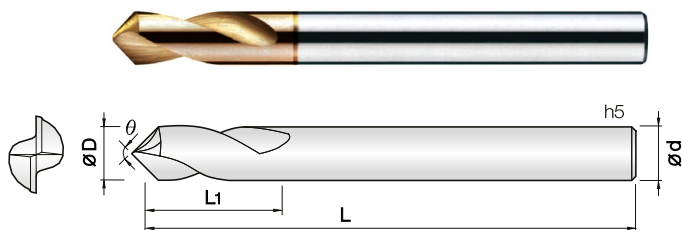

- Určeno pro obrábění různých materiálů, ocelí, nástrojových ocelí, kalených ocelí do HRC 40 a litiny
- Vysoká životnost díky PVD povlaku na bázi Si
- Optimální pro navrtávání díky řezným hranám ve šroubovici 30°

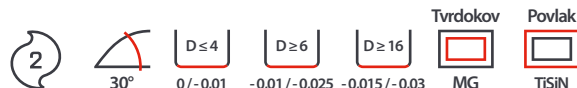

Pro **SRAŽENÍ OTVORU** (pro přesné tolerance sražení doporučujeme frézu 2STE)

NOVINKA

Objednací číslo	Úhel θ	D (mm)	L (mm)	L1 (mm)	d h5 (mm)	Standardní položky
2SPOC-003-090-040	90°	0,3	40	0,9	3	☑
2SPOC-005-090-040		0,5	40	1,5	3	☑
2SPOC-008-090-040		0,8	40	2,4	3	☑
2SPOC-010-090-050		1	50	3	3	☑
2SPOC-010-090-080			80	3	3	☑
2SPOC-015-090-050		1,5	50	4,5	3	☑
2SPOC-020-090-050		2	50	6	3	☑
2SPOC-020-090-080			80	6	3	☑
2SPOC-030-090-050		3	50	10	3	☑
2SPOC-030-090-100			100	10	3	☑
2SPOC-040-090-050		4	50	12	4	☑
2SPOC-040-090-100			100	12	4	☑
2SPOC-060-090-070		6	70	15	6	☑
2SPOC-060-090-110			110	15	6	☑
2SPOC-060-090-150			150	15	6	☑
2SPOC-080-090-080		8	80	25	8	☑
2SPOC-080-090-150	150		25	8	☑	
2SPOC-100-090-090	10	90	25	10	☑	
2SPOC-100-090-150		150	25	10	☑	
2SPOC-120-090-090	12	90	30	12	☑	
2SPOC-120-090-150		150	30	12	☑	
2SPOC-160-090-110	16	110	35	16	☑	

Pro **STŘEDÍCÍ OTVORY**

Objednací číslo	Úhel θ	D (mm)	L (mm)	L1 (mm)	d h5 (mm)	Standardní položky	
2SPOC-010-120-050	120°	1	50	3	3	☑	
2SPOC-020-120-050		2	50	6	3	☑	
2SPOC-030-120-050		3	50	10	3	☑	
2SPOC-030-120-100			100	10	3	☑	
2SPOC-040-120-050		4	50	12	4	☑	
2SPOC-040-120-100			100	12	4	☑	
2SPOC-060-120-070		6	70	15	6	☑	
2SPOC-060-120-110			110	15	6	☑	
2SPOC-080-120-080			8	80	25	8	☑
2SPOC-100-120-090		10	90	25	10	☑	
2SPOC-100-120-150			150	25	10	☑	
2SPOC-120-120-090		12	90	30	12	☑	
2SPOC-120-120-150			150	30	12	☑	
2SPOC-160-120-110		16	110	35	16	☑	
2SPOC-010-142-050		142°	1	50	3	3	☑
2SPOC-020-142-050			2	50	6	3	☑
2SPOC-030-142-050	3		50	9	3	☑	
2SPOC-040-142-050	4		50	12	4	☑	
2SPOC-060-142-070	6		70	15	6	☑	
2SPOC-080-142-080	8		80	25	8	☑	
2SPOC-100-142-090	10		90	25	10	☑	
2SPOC-120-142-090	12		90	30	12	☑	

▶ 2680

2-břité NC NAVRTÁVÁKY pro obrábění různých typů materiálů

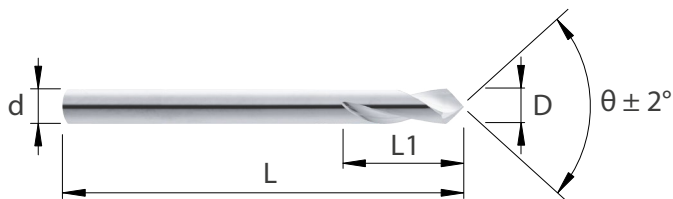

- ▶ Určeno pro obrábění různých materiálů, ocelí do HRC 40 a nerezových ocelí
- ▶ Vysoká kvalita řezných hran
- ▶ Vyrobeno ve Švýcarsku

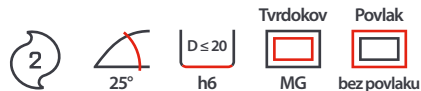

Objednací číslo	D (mm)	Úhel θ	L (mm)	L1 (mm)	d h6 (mm)	Standardní položka
2680-0,50-90	0,5	90°	39	1,5	2	☑
2680-0,50-120		120°	39	1,5	2	☑
2680-1,00-90	1	90°	39	3	2	☑
2680-1,00-120		120°	39	3	2	☑
2680-1,50-90	1,5	90°	39	4	2	☑
2680-1,50-120		120°	39	4	2	☑
2680-2,00-90	2	90°	38	8	2	☑
2680-2,00-120		120°	38	8	2	☑
2680-2,50-90	2,5	90°	38	8	2,5	☑
2680-2,50-120		120°	38	8	2,5	☑
2680-3,00-90	3	90°	38	10	3	☑
2680-3,00-120		120°	38	10	3	☑
2680-4,00-90	4	90°	50	12	4	☑
2680-4,00-120		120°	50	12	4	☑

Objednací číslo	D (mm)	Úhel θ	L (mm)	L1 (mm)	d h6 (mm)	Standardní položka
2680-5,00-90	5	90°	50	15	5	☑
2680-5,00-120		120°	50	15	5	☑
2680-6,00-90	6	90°	57	16	6	☑
2680-6,00-120		120°	57	16	6	☑
2680-8,00-90	8	90°	63	20	8	☑
2680-8,00-120		120°	63	20	8	☑
2680-10,00-90	10	90°	72	22	10	☑
2680-10,00-120		120°	72	22	10	☑
2680-12,00-90	12	90°	73	24	12	☑
2680-12,00-120		120°	73	24	12	☑
2680-16,00-90	16	90°	82	26	16	☑
2680-16,00-120		120°	82	26	16	☑
2680-20,00-90	20	90°	92	30	20	☑
2680-20,00-120		120°	92	30	20	☑

▶ 2520-2530

2-břité NC NAVRTÁVÁKY s osazenou stopkou pro obrábění různých typů materiálů

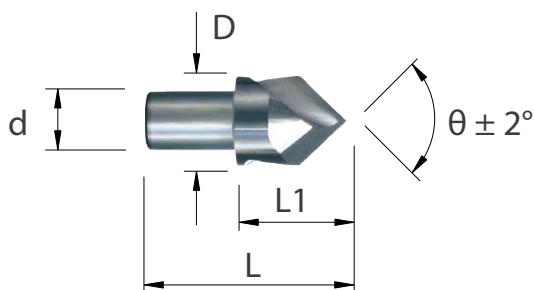

- ▶ Určeno pro obrábění různých materiálů, ocelí do HRC 40 a nerezových ocelí
- ▶ Vysoká kvalita řezných hran
- ▶ Vhodné pro dlouhotočné automaty
- ▶ Vyrobeno ve Švýcarsku

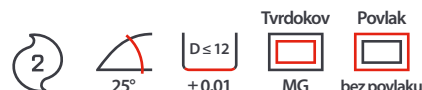

Objednací číslo	D (mm)	Úhel θ	L (mm)	L1 (mm)	d h6 (mm)	Standardní položka
2520-5	5	90°	17	8	4	☑
2530-5		120°	17	8	4	☑
2520-7	7	90°	17	8	5	☑
2530-7		120°	17	8	5	☑

Objednací číslo	D (mm)	Úhel θ	L (mm)	L1 (mm)	d h6 (mm)	Standardní položka
2520-10	10	90°	22	10	6	☑
2530-10		120°	22	10	6	☑
2520-12	12	90°	26	12	8	☑
2530-12		120°	26	12	8	☑

1STE 1-břité frézy pro gravírování pro obrábění různých typů materiálů

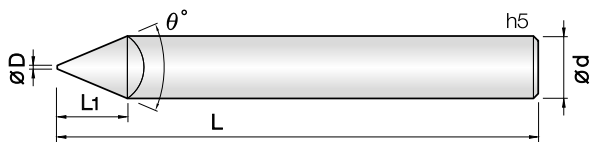

- Určeno pro obrábění různých materiálů, ocelí, nástrojových ocelí, kalených ocelí do HRC 50 a litiny
- Vysoká životnost díky PVD povlaku na bázi Si
- Optimální pro NC gravírování, srážení hran
- Minimální vyštípování díky vysoce houževnatému tvrdokovu

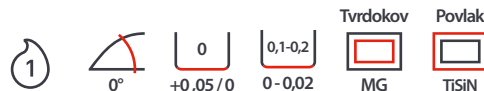

NOVINKA

Objednáací číslo	D (mm)	Úhel θ	L (mm)	L1 (mm)	d h5 (mm)	Standardní položka
1STE-000-200-S04	0	20°	40	5	4	☑
1STE-000-200-S06			50	5	6	☑
1STE-000-300-S04		30°	40	5	4	☑
1STE-000-300-S06			50	5	6	☑
1STE-000-900-S04		90°	40	2	4	☑
1STE-000-900-S06			50	3	6	☑
1STE-000-1200-S06	120°	50	1,73	6	☑	
1STE-0005-200-S04	0,05	20°	40	5	4	☑
1STE-0005-200-S06			50	5	6	☑
1STE-0005-300-S04		30°	40	5	4	☑
1STE-0005-300-S06			50	5	6	☑
1STE-0005-900-S04		90°	40	1,97	4	☑
1STE-0005-900-S06			50	2,97	6	☑
1STE-0005-1200-S06	120°	50	1,71	6	☑	
1STE-001-200-S04	0,1	20°	40	5	4	☑
1STE-001-200-S06			50	5	6	☑
1STE-001-300-S04		30°	40	5	4	☑
1STE-001-300-S06			50	5	6	☑
1STE-001-600-S04		60°	40	3,37	4	☑
1STE-001-900-S04		90°	40	1,95	4	☑
1STE-001-900-S06	50		2,95	6	☑	

Objednáací číslo	D (mm)	Úhel θ	L (mm)	L1 (mm)	d h5 (mm)	Standardní položka
1STE-001-1200-S06	0,1	120°	50	1,7	6	☑
1STE-0015-200-S04	0,15	20°	40	5	4	☑
1STE-0015-200-S06			50	5	6	☑
1STE-0015-300-S04		30°	40	5	4	☑
1STE-0015-300-S06			50	5	6	☑
1STE-0015-600-S04		60°	40	3,33	4	☑
1STE-0015-900-S04		90°	40	1,92	4	☑
1STE-0015-900-S06	50		2,92	6	☑	
1STE-0015-1200-S06	120°	50	1,68	6	☑	
1STE-002-200-S04	0,2	20°	40	5	4	☑
1STE-002-200-S06			50	5	6	☑
1STE-002-300-S04		30°	40	5	4	☑
1STE-002-300-S06			50	5	6	☑
1STE-002-600-S04		60°	40	3,29	4	☑
1STE-002-900-S04		90°	40	1,9	4	☑
1STE-002-900-S06	50		2,9	6	☑	
1STE-002-1200-S06	120°	50	1,67	6	☑	
1STE-003-200-S04	0,3	20°	40	5	4	☑
1STE-003-300-S04		30°	40	5	4	☑
1STE-003-600-S04		60°	40	3,37	4	☑
1STE-003-900-S04		90°	40	1,95	4	☑

▶ 2STEC 2-břité frézy pro srážení a gravírování pro obrábění různých typů materiálů

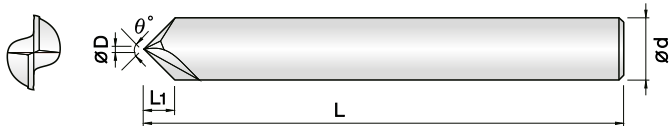

- ▶ Určeno pro obrábění různých materiálů, ocelí, nástrojových ocelí, kalených ocelí do HRC 50 a litiny
- ▶ Vysoká životnost díky PVD povlaku na bázi Si
- ▶ Optimální pro NC gravírování, srážení hran a středící otvory
- ▶ Minimální vyštipování díky vysoce houževnatému tvrdokovu



Objednací číslo	d h5 (mm)	Úhel θ	L (mm)	D (mm)	L1 (mm)	Standardní položka
2STEC-000-300-S03	3	30°	60	0	5,5	☑
2STEC-000-600-S03		60°	60	0	2,5	☑
2STEC-000-900-S03		90°	60	0	1,5	☑
2STEC-000-900-080			80	0	1,5	☑
2STEC-000-1200-S03		120°	60	0	0,86	☑
2STEC-000-300-S04	4	30°	60	0	7,4	☑
2STEC-000-600-S04		60°	60	0	3,4	☑
2STEC-000-900-S04		90°	60	0	2	☑
2STEC-000-900-100			100	0	2	☑
2STEC-000-1200-S04		120°	60	0	1,15	☑
2STEC-000-300-S06	6	30°	60	0	11,1	☑
2STEC-000-600-S06		60°	60	0	5,1	☑
2STEC-000-900-S06		90°	60	0	3	☑
2STEC-000-900-110			110	0	3	☑
2STEC-000-1200-S06		120°	60	0	1,73	☑

Objednací číslo	d h5 (mm)	Úhel θ	L (mm)	D (mm)	L1 (mm)	Standardní položka
2STEC-000-600-S08	8	60°	65	0	6,9	☑
2STEC-000-900-S08		90°	65	0	4	☑
2STEC-000-900-120			120	0	4	☑
2STEC-000-1200-S08		120°	65	0	2,3	☑
2STEC-000-600-S10		10	60°	70	0	8,6
2STEC-000-900-S10	90°		70	0	5	☑
2STEC-000-900-150			150	0	5	☑
2STEC-000-1200-S10	120°	70	0	2,88	☑	
2STEC-000-600-S12	12	60°	75	0	10,3	☑
2STEC-000-900-S12		90°	75	0	6	☑
2STEC-000-900-160			160	0	6	☑
2STEC-000-1200-S12		120°	75	0	3,46	☑

ÚHEL

RÁDIUS

DRAŽKA

▶ 3CHA 3-břité frézy na srážení pro obrábění různých typů materiálů

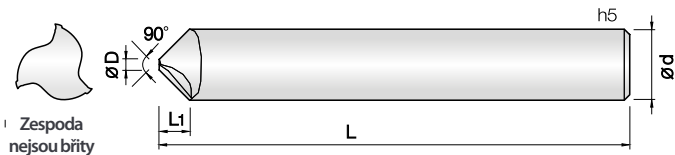

- ▶ Určeno pro obrábění různých materiálů, ocelí, nástrojových ocelí, kalených ocelí do HRC 50 a litiny
- ▶ Vysoká životnost díky PVD povlaku na bázi Si
- ▶ Minimální vyštipování díky vysoce houževnatému tvrdokovu
- ▶ Nižší řezný odpor díky 30° šroubovici



Objednací číslo	d h5 (mm)	Úhel θ	L (mm)	D (mm)	L1 (mm)	Standardní položka
3CHA-008-900-011	3	90°	50	0,8	1,1	☑
3CHA-008-900-016	4	90°	50	0,8	1,6	☑
3CHA-010-900-025	6	90°	60	1	2,5	☑

Objednací číslo	d h5 (mm)	Úhel θ	L (mm)	D (mm)	L1 (mm)	Standardní položka
3CHA-010-900-035	8	90°	65	1	3,5	☑
3CHA-020-900-045	10	90°	75	2	4,5	☑
3CHA-020-900-050	12	90°	80	2	5,0	☑

ÚHEL

RÁDIUS

▶ 4STE 4-břité frézy na srážení pro obrábění různých typů materiálů

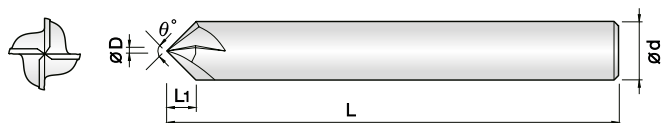

- ▶ Určeno pro obrábění různých materiálů, ocelí, nástrojových ocelí, kalených ocelí do HRC 52 a litiny
- ▶ Vysoká životnost díky PVD povlaku na bázi Si
- ▶ 4 řezné hrany pro optimální zahlubování a srážení hran
- ▶ Minimální vyštipování díky vysoce houževnatému tvrdokovu



Objednací číslo	d h5 (mm)	Úhel θ	L (mm)	D (mm)	L1 (mm)	Standardní položka
4STE-000-600-S03	3	60°	50	0	2,5	☑
4STE-000-900-S03		90°	50	0	1,5	☑
4STE-000-600-S04	4	60°	50	0	3,4	☑
4STE-000-900-S04		90°	50	0	2	☑
4STE-000-600-S06	6	60°	60	0	5,1	☑
4STE-000-900-S06		90°	60	0	3	☑

Objednací číslo	d h5 (mm)	Úhel θ	L (mm)	D (mm)	L1 (mm)	Standardní položka
4STE-000-600-S08	8	60°	65	0	6,9	☑
4STE-000-900-S08		90°	65	0	4	☑
4STE-000-600-S10	10	60°	75	0	8,6	☑
4STE-000-900-S10		90°	75	0	5	☑
4STE-000-600-S12	12	60°	80	0	10,3	☑
4STE-000-900-S12		90°	80	0	6	☑

▶ 4-6TDA

4-6-břité frézy úhlové oboustranné pro obrábění různých typů materiálů

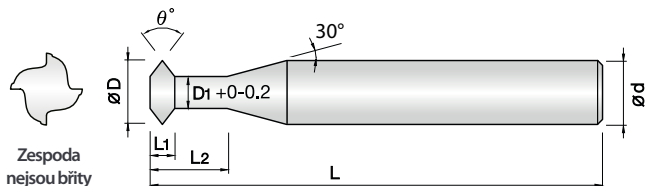
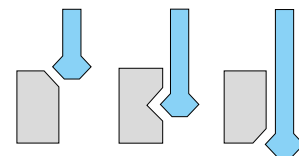

- ▶ Určeno pro obrábění různých typů materiálů a pro oceli do HRC 50
- ▶ Vysoká odolnost proti opotřebení díky JCRO povlaku
- ▶ Geometrie minimalizující vyštipování ostří



Tolerance L1

Tvrdokov

MG

Povlak

JCRO

-0,01 / -0,03

Objednáací číslo	D (mm)	Úhel θ	L2 (mm)	L1 (mm)	D1 (mm)	L (mm)	d h5 (mm)	Standardní položka
4TDA-015-600-030	1,5	60°	3	0,43	0,75	45	4	☑
4TDA-015-900-030		90°	3	0,75	0,75	45	4	☑
4TDA-020-600-050	2	60°	5	0,57	1	50	4	☑
4TDA-020-900-050		90°	5	1	1	50	4	☑
4TDA-025-600-060	2,5	60°	6	0,75	1,2	50	4	☑
4TDA-025-900-060		90°	6	1,3	1,2	50	4	☑
4TDA-030-600-075	3	60°	7,5	0,86	1,5	50	4	☑
4TDA-030-600-120			12	0,86	1,5	50	4	☑
4TDA-030-900-075		90°	7,5	1,5	1,5	50	4	☑
4TDA-030-900-120			12	1,5	1,5	50	4	☑
4TDA-040-600-100	4	60°	10	1,15	2	50	4	☑
4TDA-040-600-160			16	1,15	2	50	4	☑
4TDA-040-900-100		90°	10	2	2	50	4	☑
4TDA-040-900-160			16	2	2	50	4	☑
4TDA-050-600-125	5	60°	12,5	1,44	2,5	60	6	☑
4TDA-050-600-200			20	1,44	2,5	60	6	☑
4TDA-050-900-125		90°	12,5	2,4	2,5	60	6	☑
4TDA-050-900-200			20	2,4	2,5	60	6	☑

Objednáací číslo	D (mm)	Úhel θ	L2 (mm)	L1 (mm)	D1 (mm)	L (mm)	d h5 (mm)	Standardní položka
4TDA-060-600-150	6	60°	15	1,73	3	60	6	☑
4TDA-060-600-250			25	1,73	3	60	6	☑
4TDA-060-900-150		90°	15	2,8	3	60	6	☑
4TDA-060-900-250			25	2,8	3	60	6	☑
6TDA-080-600-200	8	60°	20	2,3	4	70	8	☑
6TDA-080-600-280			28	2,3	4	70	8	☑
6TDA-080-900-200		90°	20	3,8	4	70	8	☑
6TDA-080-900-280			28	3,8	4	70	8	☑
6TDA-100-600-250	10	60°	25	2,8	5	75	10	☑
6TDA-100-600-350			35	2,8	5	75	10	☑
6TDA-100-900-250		90°	25	4,8	6	80	10	☑
6TDA-100-900-350			35	4,8	6	80	10	☑
6TDA-120-600-300	12	60°	30	3,4	6	80	12	☑
6TDA-120-600-420			42	3,4	6	80	12	☑
6TDA-120-900-300		90°	30	5,8	6	80	12	☑
6TDA-120-900-420			42	5,8	6	80	12	☑

ÚHEL

RÁDIUS

DRAŽKA

▶ 4-6TAC

4-6-břité frézy úhlové čelní pro obrábění různých typů materiálů

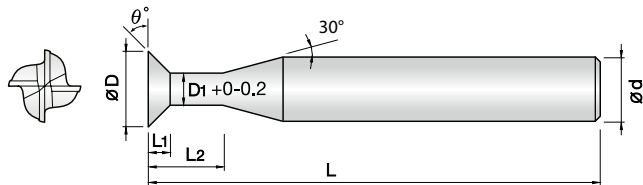
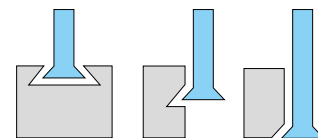

- ▶ Určeno pro obrábění různých typů materiálů a pro oceli do HRC 50
- ▶ Vysoká odolnost proti opotřebení díky JCRO povlaku
- ▶ Geometrie minimalizující vyštipování ostří

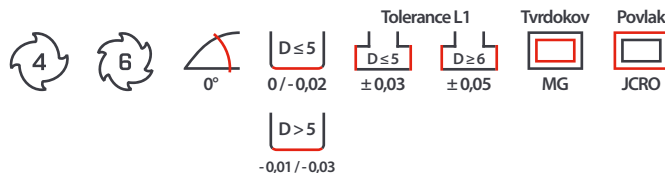

ÚHEL

Objednací číslo	D (mm)	Úhel θ	L2 (mm)	L1 (mm)	D1 (mm)	L (mm)	d h5 (mm)	Standardní položka
4TAC-015-300-030	1,5	30°	3	0,21	0,75	45	4	☑
4TAC-015-450-030		45°	3	0,37	0,75	45	4	☑
4TAC-020-300-050	2	30°	5	0,28	1	50	4	☑
4TAC-020-450-050		45°	5	0,5	1	50	4	☑
4TAC-025-300-060	2,5	30°	6	0,37	1,2	50	4	☑
4TAC-025-450-060		45°	6	0,65	1,2	50	4	☑
4TAC-030-300-075	3	30°	7,5	0,43	1,5	50	4	☑
4TAC-030-300-120			12	0,43	1,5	50	4	☑
4TAC-030-450-075		45°	7,5	0,75	1,5	50	4	☑
4TAC-030-450-120			12	0,75	1,5	50	4	☑
4TAC-040-300-100	4	30°	10	0,57	2	50	4	☑
4TAC-040-300-160			16	0,57	2	50	4	☑
4TAC-040-450-100		45°	10	1	2	50	4	☑
4TAC-040-450-160			16	1	2	50	4	☑
4TAC-050-300-125	5	30°	12,5	0,72	2,5	60	6	☑
4TAC-050-450-125		45°	12,5	1,25	2,5	60	6	☑

RÁDIUS

Objednací číslo	D (mm)	Úhel θ	L2 (mm)	L1 (mm)	D1 (mm)	L (mm)	d h5 (mm)	Standardní položka
4TAC-060-300-150	6	30°	15	0,86	3	60	6	☑
4TAC-060-300-240			24	0,86	3	60	6	☑
4TAC-060-450-150		45°	15	1,5	3	60	6	☑
4TAC-060-450-240			24	1,5	3	60	6	☑
6TAC-080-300-200	8	30°	20	1,15	4	70	8	☑
6TAC-080-300-280			28	1,15	4	70	8	☑
6TAC-080-450-200		45°	20	2	4	70	8	☑
6TAC-080-450-280			28	2	4	70	8	☑
6TAC-100-300-250	10	30°	25	1,44	5	75	10	☑
6TAC-100-300-350			35	1,44	5	75	10	☑
6TAC-100-450-250		45°	25	2,5	5	75	10	☑
6TAC-100-450-350			35	2,5	5	75	10	☑
6TAC-120-300-300	12	30°	30	1,73	6	80	12	☑
6TAC-120-300-420			42	1,73	6	80	12	☑
6TAC-120-450-300		45°	30	3	6	80	12	☑
6TAC-120-450-420			42	3	6	80	12	☑

DRAŽKA

► 2CRC 2-břité ZAObLOVACÍ frézy pro obrábění různých typů materiálů

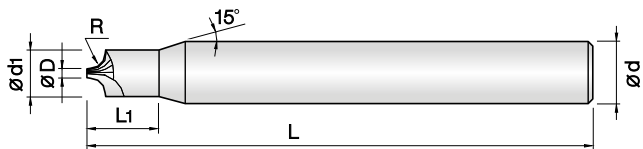

- Určeno pro obrábění různých typů materiálů a pro oceli do HRC 52
- Vysoká odolnost proti opotřebení díky PVD povlaku na bázi Si
- Velmi přesné tolerance řezných hran
- Vysoká kvalita obrobeného povrchu

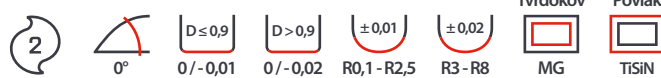

Objednací číslo	R (mm)	D (mm)	d1 (mm)	L1 (mm)	L (mm)	d h5 (mm)	Standardní položka
2CRC-005-001-S04	R0,1	0,5	0,8	2,5	45	4	☑
2CRC-005-0015-S04	R0,15	0,5	0,9	2,5	45	4	☑
2CRC-005-002-S04	R0,2	0,5	1	2,5	45	4	☑
2CRC-005-0025-S04	R0,25	0,5	1,1	2,5	45	4	☑
2CRC-005-003-S04	R0,3	0,5	1,2	2,5	45	4	☑
2CRC-005-0035-S04	R0,35	0,5	1,3	2,5	45	4	☑
2CRC-005-004-S04	R0,4	0,5	1,4	2,5	45	4	☑
2CRC-005-0045-S04	R0,45	0,5	1,5	2,5	45	4	☑
2CRC-005-005-S04	R0,5	0,5	1,6	2,5	45	4	☑
2CRC-009-005-S04		0,9	2	3	45	4	☑
2CRC-049-005-S06	R0,55	4,9	6	-	50	6	☑
2CRC-005-0055-S04		0,5	1,7	3	45	4	☑
2CRC-005-006-S04	R0,6	0,5	1,8	3	45	4	☑
2CRC-005-0065-S04	R0,65	0,5	1,9	3	45	4	☑
2CRC-005-007-S04	R0,7	0,5	2	3	45	4	☑
2CRC-009-0075-S04	R0,75	0,9	2,5	4	45	4	☑
2CRC-009-008-S04	R0,8	0,9	2,6	4	45	4	☑
2CRC-009-0085-S04	R0,85	0,9	2,7	4	45	4	☑
2CRC-009-009-S04	R0,9	0,9	2,8	4	45	4	☑

Objednací číslo	R (mm)	D (mm)	d1 (mm)	L1 (mm)	L (mm)	d h5 (mm)	Standardní položka
2CRC-009-0095-S04	R0,95	0,9	2,9	4	45	4	☑
2CRC-009-010-S06	R1	0,9	3	5	50	6	☑
2CRC-039-010-S06		3,9	6	-	50	6	☑
2CRC-059-010-S08	R1,25	5,9	8	-	60	8	☑
2CRC-009-0125-S06		0,9	3,5	5	50	6	☑
2CRC-034-0125-S06	R1,5	3,4	6	-	50	6	☑
2CRC-014-015-S06		1,4	4,5	8	50	6	☑
2CRC-049-015-S08	R2	4,9	8	-	60	8	☑
2CRC-014-020-S06		1,4	5,5	10	50	6	☑
2CRC-039-020-S08	R2,5	3,9	8	-	60	8	☑
2CRC-019-025-S08		1,9	7	13	60	8	☑
2CRC-019-030-S08	R3	1,9	8	-	60	8	☑
2CRC-019-035-S10	R3,5	1,9	9	13	70	10	☑
2CRC-019-040-S10	R4	1,9	10	-	70	10	☑
2CRC-019-045-S12	R4,5	1,9	11	13	80	12	☑
2CRC-019-050-S12	R5	1,9	12	-	80	12	☑
2CRC-039-060-S16	R6	3,9	16	-	85	16	☑
2CRC-059-070-S20	R7	5,9	20	-	85	20	☑
2CRC-039-080-S20	R8	3,9	20	-	85	20	☑

► 4CRC 4-břité ZAObLOVACÍ frézy pro obrábění různých typů materiálů

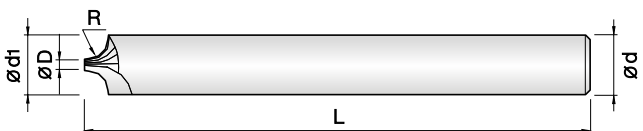

- Určeno pro obrábění různých typů materiálů a pro oceli do HRC 52
- Vysoká odolnost proti opotřebení díky PVD povlaku na bázi Si
- Velmi přesné tolerance řezných hran
- Vysoká kvalita obrobeného povrchu

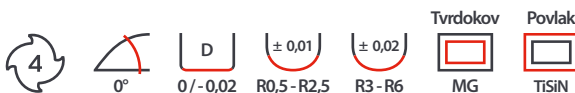

Objednací číslo	R (mm)	D (mm)	d1 (mm)	L (mm)	d h5 (mm)	Standardní položka
4CRC-029-005-S04	R0,5	2,9	4	50	4	☑
4CRC-049-005-S06		4,9	6	50	6	☑
4CRC-024-0075-S04	R0,75	2,4	4	50	4	☑
4CRC-044-0075-S06		4,4	6	50	6	☑
4CRC-019-010-S04	R1	1,9	4	50	4	☑
4CRC-039-010-S06		3,9	6	50	6	☑
4CRC-059-010-S08	R1,5	5,9	8	60	8	☑
4CRC-049-015-S08		4,9	8	60	8	☑

Objednací číslo	R (mm)	D (mm)	d1 (mm)	L (mm)	d h5 (mm)	Standardní položka
4CRC-039-020-S08	R2	3,9	8	60	8	☑
4CRC-059-020-S10		5,9	10	70	10	☑
4CRC-049-025-S10	R2,5	4,9	10	70	10	☑
4CRC-039-030-S10		3,9	10	70	10	☑
4CRC-059-030-S12	R3	5,9	12	75	12	☑
4CRC-039-040-S12		3,9	12	75	12	☑
4CRC-059-050-S16	R5	5,9	16	80	16	☑
4CRC-039-060-S16	R6	3,9	16	80	16	☑

▶ 3TRC

3-břité ZAObLOVACÍ oboustranné frézy pro obrábění různých typů materiálů

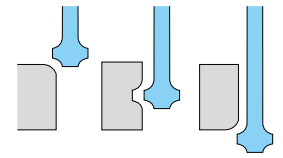

- ▶ Určeno pro obrábění různých typů materiálů a pro oceli do HRC 50
- ▶ Vysoká odolnost proti opotřeбенí díky JCRO povlaku
- ▶ Geometrie minimalizující vyštipování ostří

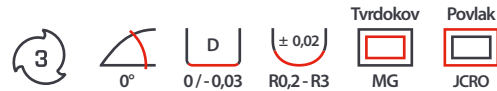
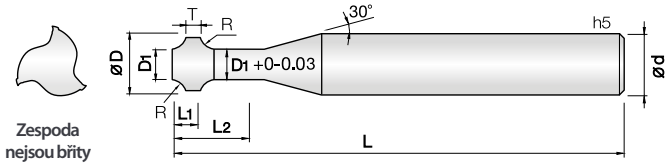

Objednací číslo	R (mm)	L2 (mm)	D (mm)	D1 (mm)	T (mm)	L1 (mm)	L (mm)	d h5 (mm)	Standardní položka
3TRC-019-002-080	R0,2	8	1,9	1,45	0,9	1,45	60	4	<input checked="" type="checkbox"/>
3TRC-024-003-090	R0,3	9	2,4	1,75	1,2	1,95	60	4	<input checked="" type="checkbox"/>
3TRC-026-004-100	R0,4	10	2,6	1,75	1,5	2,5	60	4	<input checked="" type="checkbox"/>
3TRC-029-005-120	R0,5	12	2,9	1,85	1,8	3	60	4	<input checked="" type="checkbox"/>
3TRC-049-005-150		15	4,9	3,8	2	3,3	80	6	<input checked="" type="checkbox"/>
3TRC-068-010-200	R1	20	6,8	4,7	2,2	4,3	80	8	<input checked="" type="checkbox"/>
3TRC-079-015-250	R1,5	25	7,9	4,7	2,5	5,8	80	8	<input checked="" type="checkbox"/>
3TRC-099-020-300	R2	30	9,9	5,8	2,8	6,8	80	10	<input checked="" type="checkbox"/>
3TRC-119-030-350	R3	35	11,9	5,8	3	8,8	80	12	<input checked="" type="checkbox"/>

ÚHEL

RÁDIUS

DRAŽKA

▶ 4JJSPM 4-břité KULOVÉ frézy 270° pro 3D obrábění v různých typech materiálů

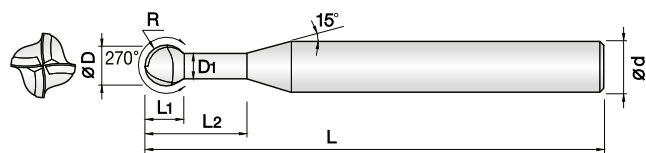

- ▶ Určeno pro obrábění různých druhů materiálů a ocelí do HRC 68
- ▶ Vysoká odolnost proti opotřeбенí díky PVD povlaku na bázi Si
- ▶ Velmi přesné tolerance řezných hran
- ▶ 270° radius pro vyšší rozsah 3D obrábění
- ▶ Vyšší posuvy díky 4 řezným hranám
- ▶ Vynikající výkon při vysokých řezných rychlostech díky 0,2 μm tvrdokovu

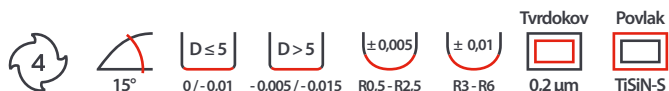

Objednací číslo	D (mm)	R (mm)	L2 (mm)	L1 (mm)	D1 (mm)	L (mm)	d h5 (mm)	Standardní položka
4JJSPM-010-040-S06	1	R0,5	4	0,8	0,7	60	6	<input checked="" type="checkbox"/>
4JJSPM-010-060-S06			6	0,8	0,7	60	6	<input checked="" type="checkbox"/>
4JJSPM-015-060-S06	1,5	R0,75	6	1,2	1	60	6	<input checked="" type="checkbox"/>
4JJSPM-015-080-S06			8	1,2	1	60	6	<input checked="" type="checkbox"/>
4JJSPM-020-060-S06	2	R1	6	1,7	1,4	60	6	<input checked="" type="checkbox"/>
4JJSPM-020-100-S06			10	1,7	1,4	60	6	<input checked="" type="checkbox"/>
4JJSPM-030-100-S06	3	R1,5	10	2,5	2,1	70	6	<input checked="" type="checkbox"/>
4JJSPM-030-150-S06			15	2,5	2,1	70	6	<input checked="" type="checkbox"/>
4JJSPM-040-120-S06	4	R2	12	3,4	2,8	70	6	<input checked="" type="checkbox"/>
4JJSPM-040-200-S06			20	3,4	2,8	70	6	<input checked="" type="checkbox"/>
4JJSPM-060-150-S06	6	R3	15	5,1	4,2	90	6	<input checked="" type="checkbox"/>
4JJSPM-060-300-S06			30	5,1	4,2	90	6	<input checked="" type="checkbox"/>

ÚHEL

RÁDIUS

DRAŽKA

► 4TESC 4-břité T-frézy pro drážky pro obrábění různých typů materiálů

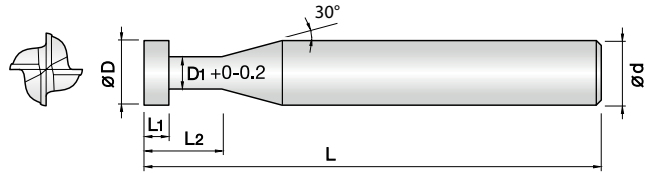

- Určeno pro obrábění různých typů materiálů a pro oceli do HRC 50
- Vysoká odolnost proti opotřebení díky JCRO povlaku
- Geometrie minimalizující vyštipování ostří
- Přesné tolerance řezných hran

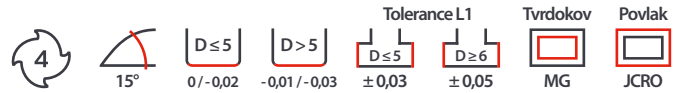

ÚHEL	Objednací číslo	D (mm)	L1 (mm)	L2 (mm)	D1 (mm)	L (mm)	d h5 (mm)	Standardní položka
ÚHEL	4TESC-020-003-040	2	0,3	4	1	50	6	<input checked="" type="checkbox"/>
	4TESC-020-005-040		0,5	4	1	50	6	<input checked="" type="checkbox"/>
	4TESC-030-003-045	3	0,3	4,5	1,5	50	6	<input checked="" type="checkbox"/>
4TESC-030-005-045	0,5		4,5	1,5	50	6	<input checked="" type="checkbox"/>	
4TESC-030-010-045	1		4,5	1,5	50	6	<input checked="" type="checkbox"/>	
RÁDIUS	4TESC-040-003-050	4	0,3	5	2	50	6	<input checked="" type="checkbox"/>
	4TESC-040-005-050		0,5	5	2	50	6	<input checked="" type="checkbox"/>
	4TESC-040-010-050		1	5	2	50	6	<input checked="" type="checkbox"/>
RÁDIUS	4TESC-050-005-045	5	0,5	4,5	2,5	50	6	<input checked="" type="checkbox"/>
	4TESC-050-010-050		1	5	2,5	50	6	<input checked="" type="checkbox"/>
	4TESC-050-015-055		1,5	5,5	2,5	50	6	<input checked="" type="checkbox"/>
RÁDIUS	4TESC-050-020-060	6	2	6	2,5	50	6	<input checked="" type="checkbox"/>
	4TESC-060-005-045		0,5	4,5	3	60	6	<input checked="" type="checkbox"/>
	4TESC-060-010-050		1	5	3	60	6	<input checked="" type="checkbox"/>
RÁDIUS	4TESC-060-015-055	6	1,5	5,5	3	60	6	<input checked="" type="checkbox"/>
	4TESC-060-020-060		2	6	3	60	6	<input checked="" type="checkbox"/>
	4TESC-080-005-045		0,5	4,5	4	60	8	<input checked="" type="checkbox"/>
RÁDIUS	4TESC-080-010-050	8	1	5	4	60	8	<input checked="" type="checkbox"/>
	4TESC-080-015-055		1,5	5,5	4	60	8	<input checked="" type="checkbox"/>
	4TESC-080-020-060		2	6	4	60	8	<input checked="" type="checkbox"/>
DŘÁŽKA	4TESC-080-030-070	8	3	7	4	60	8	<input checked="" type="checkbox"/>
	4TESC-100-010-070		1	7	5	70	10	<input checked="" type="checkbox"/>
	4TESC-100-020-080		2	8	5	70	10	<input checked="" type="checkbox"/>
	4TESC-100-030-090	3	9	5	70	10	<input checked="" type="checkbox"/>	

► 4TRS 4-břité T-rádusové frézy pro drážky v různých typech materiálů

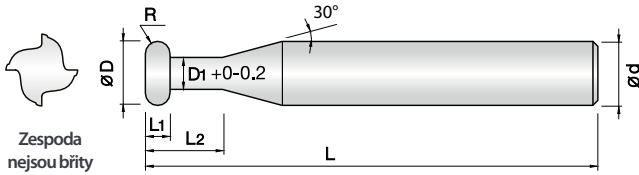

- Určeno pro obrábění různých typů materiálů a pro oceli do HRC 50
- Vysoká odolnost proti opotřezení díky JCRO povlaku
- Geometrie minimalizující vyštipování ostří
- Přesné tolerance řezných hran

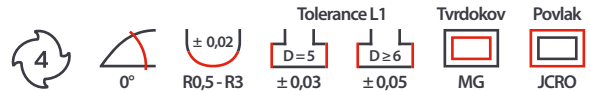

Objednací číslo	D (mm)	R (mm)	L2 (mm)	L1 (mm)	D1 (mm)	L (mm)	d h5 (mm)	Standardní položka
4TRS-050-010-045	5	R0,5	4,5	1	2,5	50	6	<input checked="" type="checkbox"/>
4TRS-050-010-070			7	1	2,5	50	6	<input checked="" type="checkbox"/>
4TRS-050-020-055		R1	5,5	2	2,5	50	6	<input checked="" type="checkbox"/>
4TRS-060-010-050	6	R0,5	5	1	3	50	6	<input checked="" type="checkbox"/>
4TRS-060-010-080			8	1	3	50	6	<input checked="" type="checkbox"/>
4TRS-060-015-055		R0,75	5,5	1,5	3	50	6	<input checked="" type="checkbox"/>
4TRS-060-020-060		R1	6	2	3	50	6	<input checked="" type="checkbox"/>
4TRS-060-020-100			10	2	3	50	6	<input checked="" type="checkbox"/>
4TRS-080-020-070	8	R1	7	2	4	60	8	<input checked="" type="checkbox"/>
4TRS-080-020-130			13	2	4	60	8	<input checked="" type="checkbox"/>
4TRS-080-030-080		R1,5	8	3	4	60	8	<input checked="" type="checkbox"/>
4TRS-100-040-100	10	R2	10	4	4,5	70	10	<input checked="" type="checkbox"/>
4TRS-100-040-160			16	4	4,5	70	10	<input checked="" type="checkbox"/>
4TRS-120-060-150	12	R3	15	6	5	75	12	<input checked="" type="checkbox"/>
4TRS-120-060-210			21	6	5	75	12	<input checked="" type="checkbox"/>

ÚHEL

RÁDIUS

DRÁŽKA

Pilové kotouče z tvrdokovu



Příklad objednávky:

1101 - 25 / 8 - 0,50 - Z64 10 ks

↑ Typ ↑ D1 ↑ D2 ↑ Tloušťka ↑ Počet zubů

Jak vybrat POČET ZUBŮ pilového kotouče?

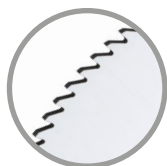

Jemnozubé Typ 1101

SWISS MADE

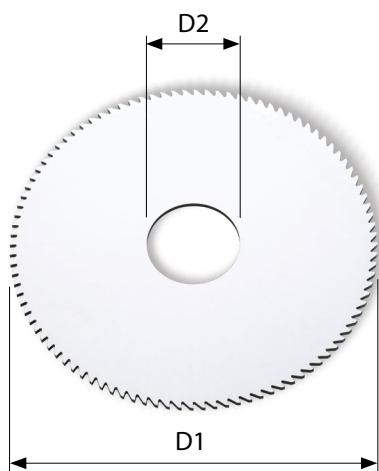

Typ 1103 extra jemnozubý naleznete na str. 18.



Hrubozubé Typ 1102

SWISS MADE

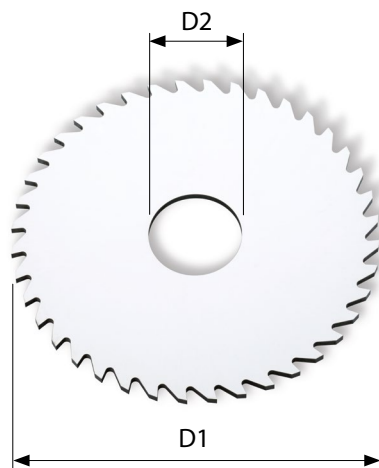

D1 js12 (mm)	Ø15		Ø20		Ø25	
	5		5		8	
D2 H7 (mm)						
Tloušťka ±0,01 (mm)	Počet zubů					
0,10	64z	<input checked="" type="checkbox"/>	80z	<input checked="" type="checkbox"/>	80z	<input checked="" type="checkbox"/>
0,15	64z	<input checked="" type="checkbox"/>	80z	<input checked="" type="checkbox"/>	80z	<input checked="" type="checkbox"/>
0,20	64z	<input checked="" type="checkbox"/>	80z	<input checked="" type="checkbox"/>	80z	<input checked="" type="checkbox"/>
0,25	64z	<input checked="" type="checkbox"/>	64z	<input checked="" type="checkbox"/>	80z	<input checked="" type="checkbox"/>
0,30	64z	<input checked="" type="checkbox"/>	64z	<input checked="" type="checkbox"/>	80z	<input checked="" type="checkbox"/>
0,35	64z	<input checked="" type="checkbox"/>	64z	<input checked="" type="checkbox"/>	64z	<input checked="" type="checkbox"/>
0,40	64z	<input checked="" type="checkbox"/>	64z	<input checked="" type="checkbox"/>	64z	<input checked="" type="checkbox"/>
0,45	48z	<input checked="" type="checkbox"/>	48z	<input checked="" type="checkbox"/>	64z	<input checked="" type="checkbox"/>
0,50	48z	<input checked="" type="checkbox"/>	48z	<input checked="" type="checkbox"/>	64z	<input checked="" type="checkbox"/>
0,60	48z	<input checked="" type="checkbox"/>	48z	<input checked="" type="checkbox"/>	64z	<input checked="" type="checkbox"/>
0,70	48z	<input checked="" type="checkbox"/>	48z	<input checked="" type="checkbox"/>	48z	<input checked="" type="checkbox"/>
0,80	40z	<input checked="" type="checkbox"/>	40z	<input checked="" type="checkbox"/>	48z	<input checked="" type="checkbox"/>
0,90	40z	<input checked="" type="checkbox"/>	40z	<input checked="" type="checkbox"/>	48z	<input checked="" type="checkbox"/>
1,00	40z	<input checked="" type="checkbox"/>	40z	<input checked="" type="checkbox"/>	48z	<input checked="" type="checkbox"/>
1,10	40z	<input checked="" type="checkbox"/>	40z	<input checked="" type="checkbox"/>	48z	<input checked="" type="checkbox"/>
1,20	40z	<input checked="" type="checkbox"/>	40z	<input checked="" type="checkbox"/>	48z	<input checked="" type="checkbox"/>
1,30	40z	<input checked="" type="checkbox"/>	40z	<input checked="" type="checkbox"/>	40z	<input checked="" type="checkbox"/>
1,40	40z	<input checked="" type="checkbox"/>	40z	<input checked="" type="checkbox"/>	40z	<input checked="" type="checkbox"/>
1,50	40z	<input checked="" type="checkbox"/>	40z	<input checked="" type="checkbox"/>	40z	<input checked="" type="checkbox"/>
1,60	40z	<input checked="" type="checkbox"/>	40z	<input checked="" type="checkbox"/>	40z	<input checked="" type="checkbox"/>
1,70	40z	<input checked="" type="checkbox"/>	32z	<input checked="" type="checkbox"/>	40z	<input checked="" type="checkbox"/>
1,80	40z	<input checked="" type="checkbox"/>	32z	<input checked="" type="checkbox"/>	40z	<input checked="" type="checkbox"/>
1,90	40z	<input checked="" type="checkbox"/>	32z	<input checked="" type="checkbox"/>	40z	<input checked="" type="checkbox"/>
2,00	40z	<input checked="" type="checkbox"/>	32z	<input checked="" type="checkbox"/>	40z	<input checked="" type="checkbox"/>
2,50	40z	<input checked="" type="checkbox"/>	32z	<input checked="" type="checkbox"/>	40z	<input checked="" type="checkbox"/>
3,00	40z	<input checked="" type="checkbox"/>	32z	<input checked="" type="checkbox"/>	32z	<input checked="" type="checkbox"/>
3,50	24z	na poptání	24z	na poptání	32z	na poptání
4,00	24z	na poptání	24z	na poptání	32z	na poptání
5,00	24z	na poptání	24z	na poptání	32z	na poptání
6,00	24z	na poptání	24z	na poptání	24z	na poptání

D1 js12 (mm)	Ø 15		Ø 20		Ø 25	
	5		5		8	
D2 H7 (mm)						
Tloušťka ±0,01 (mm)	Počet zubů					
0,20	20z	<input checked="" type="checkbox"/>	20z	<input checked="" type="checkbox"/>	20z	<input checked="" type="checkbox"/>
0,25	20z	<input checked="" type="checkbox"/>	20z	<input checked="" type="checkbox"/>	20z	<input checked="" type="checkbox"/>
0,30	20z	<input checked="" type="checkbox"/>	20z	<input checked="" type="checkbox"/>	20z	<input checked="" type="checkbox"/>
0,40	20z	<input checked="" type="checkbox"/>	20z	<input checked="" type="checkbox"/>	20z	<input checked="" type="checkbox"/>
0,50	20z	<input checked="" type="checkbox"/>	20z	<input checked="" type="checkbox"/>	20z	<input checked="" type="checkbox"/>
0,60	20z	<input checked="" type="checkbox"/>	20z	<input checked="" type="checkbox"/>	20z	<input checked="" type="checkbox"/>
0,70	20z	<input checked="" type="checkbox"/>	20z	<input checked="" type="checkbox"/>	20z	<input checked="" type="checkbox"/>
0,80	20z	<input checked="" type="checkbox"/>	20z	<input checked="" type="checkbox"/>	20z	<input checked="" type="checkbox"/>
0,90	20z	<input checked="" type="checkbox"/>	20z	<input checked="" type="checkbox"/>	20z	<input checked="" type="checkbox"/>
1,00	20z	<input checked="" type="checkbox"/>	20z	<input checked="" type="checkbox"/>	20z	<input checked="" type="checkbox"/>
1,20	20z	<input checked="" type="checkbox"/>	20z	<input checked="" type="checkbox"/>	20z	<input checked="" type="checkbox"/>
1,50	20z	<input checked="" type="checkbox"/>	20z	<input checked="" type="checkbox"/>	20z	<input checked="" type="checkbox"/>
1,60	20z	<input checked="" type="checkbox"/>	20z	<input checked="" type="checkbox"/>	20z	<input checked="" type="checkbox"/>
1,80	20z	<input checked="" type="checkbox"/>	20z	<input checked="" type="checkbox"/>	20z	<input checked="" type="checkbox"/>
2,00	20z	<input checked="" type="checkbox"/>	20z	<input checked="" type="checkbox"/>	20z	<input checked="" type="checkbox"/>
2,50	20z	<input checked="" type="checkbox"/>	20z	<input checked="" type="checkbox"/>	20z	<input checked="" type="checkbox"/>
3,00	20z	<input checked="" type="checkbox"/>	20z	<input checked="" type="checkbox"/>	20z	<input checked="" type="checkbox"/>
4,00	20z	na poptání	20z	na poptání	20z	na poptání
5,00	20z	na poptání	20z	na poptání	20z	na poptání
6,00	20z	na poptání	20z	na poptání	20z	na poptání

► Pilové kotouče z tvrdokovu

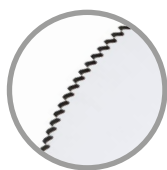

EXTRA
Jemnozubé
Typ 1103

SWISS MADE

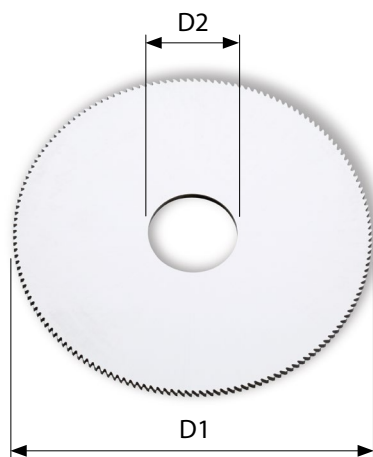

* = tyto pilové kotouče naleznete u typu 1101

D1 js12 (mm)	Ø 8	Ø 10	Ø 12	Ø 15	Ø 20		Ø 25			Ø 30	Ø 32	D1 js12 (mm)	
D2 H7 (mm)	3	3	5	5	5		6	5	6	8	8	8	D2 H7 (mm)
Počet zubů	48z	64z	64z	80z	80z	100z	80z	80z	100z	100z	100z	80z	Počet zubů
Tloušťka ±0,01 (mm)	Kč/ks bez DPH												Tloušťka ±0,01 (mm)
0,10	✓	✓	✓	✓	*	✓	✓	✓					0,10
0,15	✓	✓	✓	✓	*	✓	✓	✓	✓	✓	*	✓	0,15
0,20	✓	✓	✓	✓	*	✓	✓	✓	✓	✓	*	✓	0,20
0,25	✓	✓	✓	✓	✓	✓	✓	✓	✓	✓	*	✓	0,25
0,30	✓	✓	✓	✓	✓	✓	✓	✓	✓	✓	✓	✓	0,30
0,35	✓	✓	✓	✓	✓		✓	✓	✓	✓	✓	✓	0,35
0,40	✓	✓	✓	✓	✓	✓	✓	✓	✓	✓	✓	✓	0,40
0,50	✓	✓	✓	✓	✓	✓	✓	✓	✓	✓	✓	✓	0,50
0,60	✓	✓	✓	✓	✓		✓	✓	✓	✓	✓	✓	0,60
0,70	✓	✓	✓	✓	✓		✓	✓	✓	✓	✓	✓	0,70
0,80	✓	✓	✓	✓	✓		✓	✓	✓	✓	✓	✓	0,80
0,90	✓	✓	✓	✓	✓		✓	✓	✓	✓	✓	✓	0,90
1,00	✓	✓	✓	✓	✓		✓	✓	✓	✓	✓	✓	1,00
1,20				✓	✓		✓	✓	✓	✓	✓	✓	1,20
1,50				✓	✓		✓	✓	✓	✓	✓	✓	1,50
2,00				✓	✓		✓	✓	✓	✓	✓	✓	2,00
2,50				✓	✓		✓	✓	✓	✓	✓	✓	2,50
3,00				✓	✓		✓	✓	✓	✓	✓	✓	3,00

D1 js12 (mm)	Ø35	Ø40		Ø45		Ø50		Ø63	Ø80	D1 js12 (mm)		
D2 H7 (mm)	8	8		10		8		10	13	16	16	D2 H7 (mm)
Počet zubů	96z	100z	160z	100z	160z	100z	160z	100z	120	120z	128z	Počet zubů
Tloušťka ±0,01 (mm)											Tloušťka ±0,01 (mm)	
0,10												0,10
0,15	✓	✓	✓	✓	✓	✓	✓					0,15
0,20	✓	✓	✓	✓	✓	✓	✓	✓				0,20
0,25	✓	✓	✓	□	✓	✓	✓	✓	✓	✓		0,25
0,30	✓	✓	✓	□	✓	✓	✓	✓	✓	✓		0,30
0,35	✓	✓	✓	□	✓	✓	✓	✓	✓	✓		0,35
0,40	✓	✓	✓	□	✓	✓	✓	✓	✓	✓		0,40
0,50	✓	✓	✓	✓	✓	✓	✓	✓	✓	✓	na poptání	0,50
0,60	✓	✓	✓	✓	✓	✓	✓	✓	✓	✓	na poptání	0,60
0,70	✓	✓	✓	✓	✓	✓	✓	✓	✓	✓	na poptání	0,70
0,80	✓	✓	✓	✓	✓	✓	✓	✓	✓	✓	na poptání	0,80
0,90	✓	✓	✓	✓	✓	✓	✓	✓	✓	✓	na poptání	0,90
1,00	✓	✓	✓	✓	✓	✓	✓	✓	✓	✓	na poptání	1,00
1,20	✓	✓	✓	✓	✓	✓	✓	✓	✓	✓	na poptání	1,20
1,50	✓	✓	✓	✓	✓	✓	✓	✓	✓	✓	na poptání	1,50
2,00	✓	✓	✓	✓	✓	✓	✓	✓	✓	✓	na poptání	2,00
2,50	✓	✓	✓	✓	✓	✓	✓	✓	✓	✓	na poptání	2,50
3,00	✓	✓	✓	✓	✓	✓	✓	✓	✓	✓	na poptání	3,00

► Upínací trny pro pilové kotouče

Upínací trny s ČELNÍM upínáním

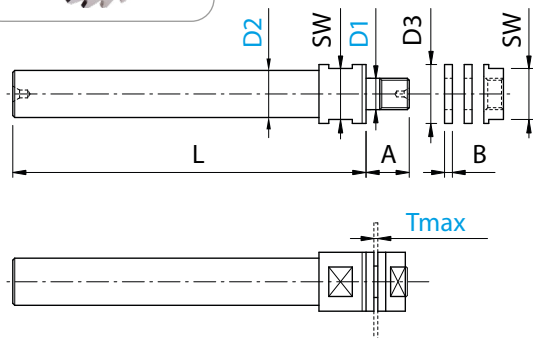

SWISS MADE

Objednáací číslo	D1 h6 (mm)	D2 h6 (mm)	D3 (mm)	L (mm)	A (mm)	B (mm)	SW (mm)	Tmax (mm)	Standardní položka
Pro PRAVÉ otáčky (čelní upínání s pravým závitem)									
2815-3-5	3,0	5,0	5,0	60	7,0	1,0	4,0	3,0	<input checked="" type="checkbox"/>
2815-5-6		6,0	7,5	70	7,0	1,0	6,0		<input checked="" type="checkbox"/>
2810-5-6	5,0	6,0	10,0	70	9,0	2,0	8,0	6,0	<input checked="" type="checkbox"/>
2810-5-10		10,0	10,0	80	9,0	2,0	8,0		<input checked="" type="checkbox"/>
2810-6-10	6,0	10,0	12,0	80	9,5	2,0	10,0		<input checked="" type="checkbox"/>
2810-8-10	8,0	10,0	15,0	80	10,0	2,0	13,0		<input checked="" type="checkbox"/>
2810-8-12		12,0	15,0	90	10,0	2,0	13,0	<input checked="" type="checkbox"/>	
2810-10-6	6,0	18,0	18,0	80	10,5	2,0	15,0	6,0	<input checked="" type="checkbox"/>
2810-10-10	10,0	10,0	18,0	80	10,5	2,0	15,0		<input checked="" type="checkbox"/>
2810-10-16		16,0	18,0	100	10,5	2,0	15,0	<input checked="" type="checkbox"/>	
2810-13-16	13,0	16,0	22,0	110	11,0	2,0	19,0	<input checked="" type="checkbox"/>	
2811-16-10	16,0	10,0	22,0	80	8,0	2,0	19,0	3,0	<input checked="" type="checkbox"/>
2810-16-20		20,0	26,0	120	12,0	2,0	22,0	6,0	<input checked="" type="checkbox"/>
2810-22-16	22,0	16,0	32,0	132	13,0	2,0	27,0		<input checked="" type="checkbox"/>

Upínací trny se ZADNÍM upínáním

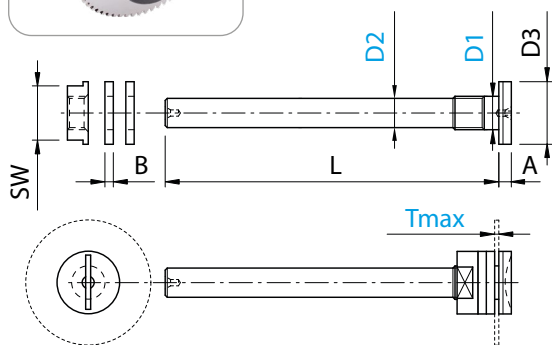

SWISS MADE

Objednáací číslo	D1 h6 (mm)	D2 h6 (mm)	D3 (mm)	L (mm)	A (mm)	B (mm)	SW (mm)	Tmax (mm)	Standardní položka
Pro PRAVÉ otáčky (zadní upínání s levým závitem)									
2820-5-4	5,0	4,0	10,0	50	3,0	2,0	8,0	6,0	<input checked="" type="checkbox"/>
2820-6-5	6,0	5,0	12,0	60	3,0	2,0	10,0		<input checked="" type="checkbox"/>
2820-8-6	8,0	6,0	15,0	70	3,0	2,0	13,0		<input checked="" type="checkbox"/>
2820-8-7	8,0	7,0	15,0	80	3,0	2,0	13,0		<input checked="" type="checkbox"/>
2820-10-6	10,0	6,0	18,0	70	3,5	2,0	15,0		<input checked="" type="checkbox"/>
2820-10-8	10,0	8,0	18,0	90	3,5	2,0	15,0		<input checked="" type="checkbox"/>
2820-13-10	13,0	10,0	22,0	110	3,5	2,0	19,0		<input checked="" type="checkbox"/>
2820-16-12	16,0	12,0	26,0	120	3,5	2,0	22,0		<input checked="" type="checkbox"/>
Pro LEVÉ otáčky (zadní upínání s pravým závitem)									
1820-5-4	5,0	4,0	10,0	50	3,0	2,0	8,0	6,0	<input checked="" type="checkbox"/>
1820-6-5	6,0	5,0	12,0	60	3,0	2,0	10,0		<input checked="" type="checkbox"/>
1820-8-6	8,0	6,0	15,0	70	3,0	2,0	13,0		<input checked="" type="checkbox"/>
1820-10-6	10,0	6,0	18,0	70	3,5	2,0	15,0		<input checked="" type="checkbox"/>

ÚHEL

RÁDIUS

DRÁŽKA

PRECIZNÍ UPÍNAČE

které dostanou z Vašich nástrojů maximum:

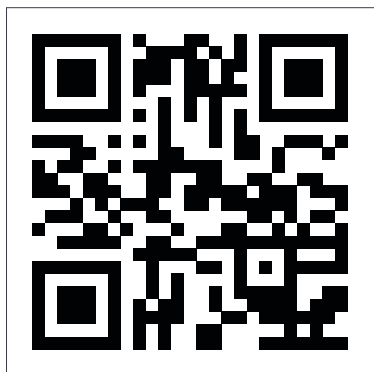

www.pm-tech.cz/upinace

